



# 542

# HC-L



## 542 HC-L

## 18/36 Litronic

FEM  
Technical Data

# LIEBHERR

Tower Cranes

FEM

# **542 HC-L 18/36 Litronic**

<b>Kranaufbauten</b> · Crane superstructures · Superstructures de grue · Sovrastrutture Superestructuras para grúas · Estruturas da grua · Конструкции крана .....	<b>04</b>
<b>Ausladung und Hubhöhe</b> · Radius and hoisting height · Portée et hauteur de levage · Sbraccio e altezza di sollevamento · Alcance y altura de elevación Alcance e altura de elevação · Вылет и Высота подъема .....	<b>05</b>
<b>Ausladung und Tragfähigkeit</b> · Radius and capacity · Portée et charge Sbraccio e portata · Alcances y cargas · Alcance e capacidade de carga Вылет и грузоподъемность.....	<b>06</b>
<b>Turmhöhen</b> · Tower heights · Hauteur de mât · Altezze torre Alturas de torre · Alturas de torre · Высота башни .....	<b>07</b>
<b>Klettern im Gebäude</b> · Climbing in the building · Télescopage dans le bâtiment Pure varianti di gru allungabili · Subida no edificio · Trepado dentro del edificio Самоподъём крана в здании .....	<b>08</b>
<b>Antriebe</b> · Driving units · Mécanismes d'entraînement · Meccanismi Mecanismos · Mecanismos · Приводы .....	<b>09</b>
<b>Ballast</b> · Counterweight · Contrepoids · Zavorra · Lastre · Lastro · Балласт .....	<b>10</b>
<b>Transport</b> · Transport · Transport · Trasporto · Transporte · Transporte · Транспорт .....	<b>11</b>
<b>Kolli-Liste</b> · Packing List · Liste de colisage · Lista dei colli · Lista de contenido Lista de embalagem · Упаковочный лист .....	<b>11</b>

**Kranaufbauten** - Crane superstructures - Superstructures de grue - Sovrastrutture  
 Superestructuras para grúas - Estruturas da grua - Конструкции крана

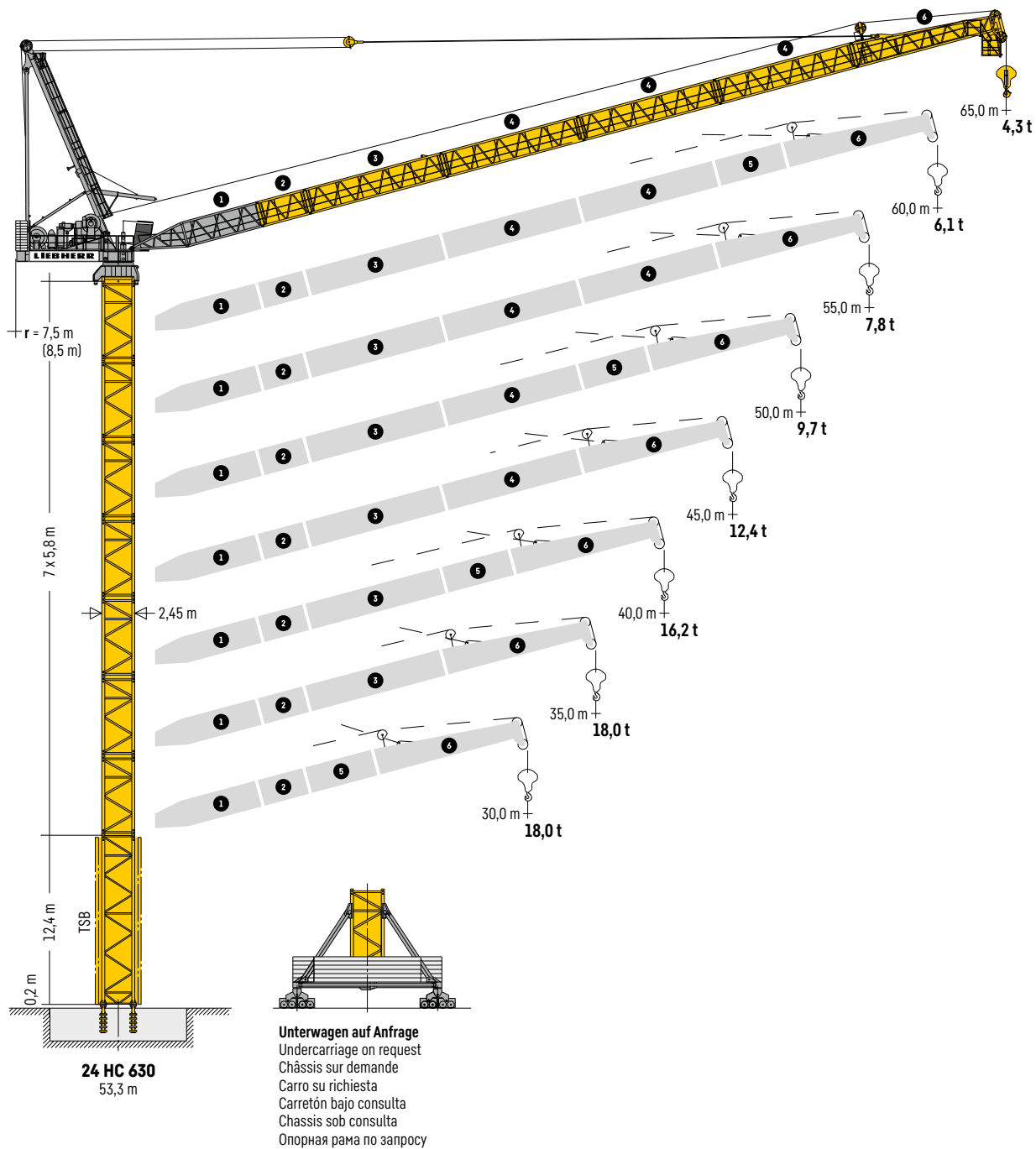

**Tragfähigkeiten gültig bis 100 m Hubhöhe. Über 100 m Hubhöhe reduziert sich die Tragfähigkeit um das zusätzliche Seilgewicht.** - Lifting capacities valid up to 100 m hoisting height. Over 100 m hoisting height, the lifting capacity is reduced by the additional rope weight. - Capacités de levage valables jusqu'à 100 m de hauteur sous crochet. Au-dessus de 100 m de hauteur sous crochet, la capacité de levage est réduite du poids de câble supplémentaire. - Portate valide fino a 100 m d'altezza di sollevamento. Oltre i 100 m si riduce la portata causa il peso addizionale della fune. - Cargas válidas hasta altura de 100 m. Por encima de los 100 m se reduce la carga por el peso adicional del cable. - Cargas válidas ate a altura de 100 m. Para além dos 100 m, reduz-se a carga pelo peso adicional do cabo. - Грузоподъемность действительна до 100 м высоты подъема. Свыше 100 м высоты подъема грузоподъемность сокращается на вес дополнительного каната.

**Ausladung und Hubhöhe** · Radius and hoisting height · Portée et hauteur de levage  
 Sbraccio e altezza di sollevamento · Alcance y altura de elevación · Alcance e altura de elevação  
 Вылет и Высота подъема

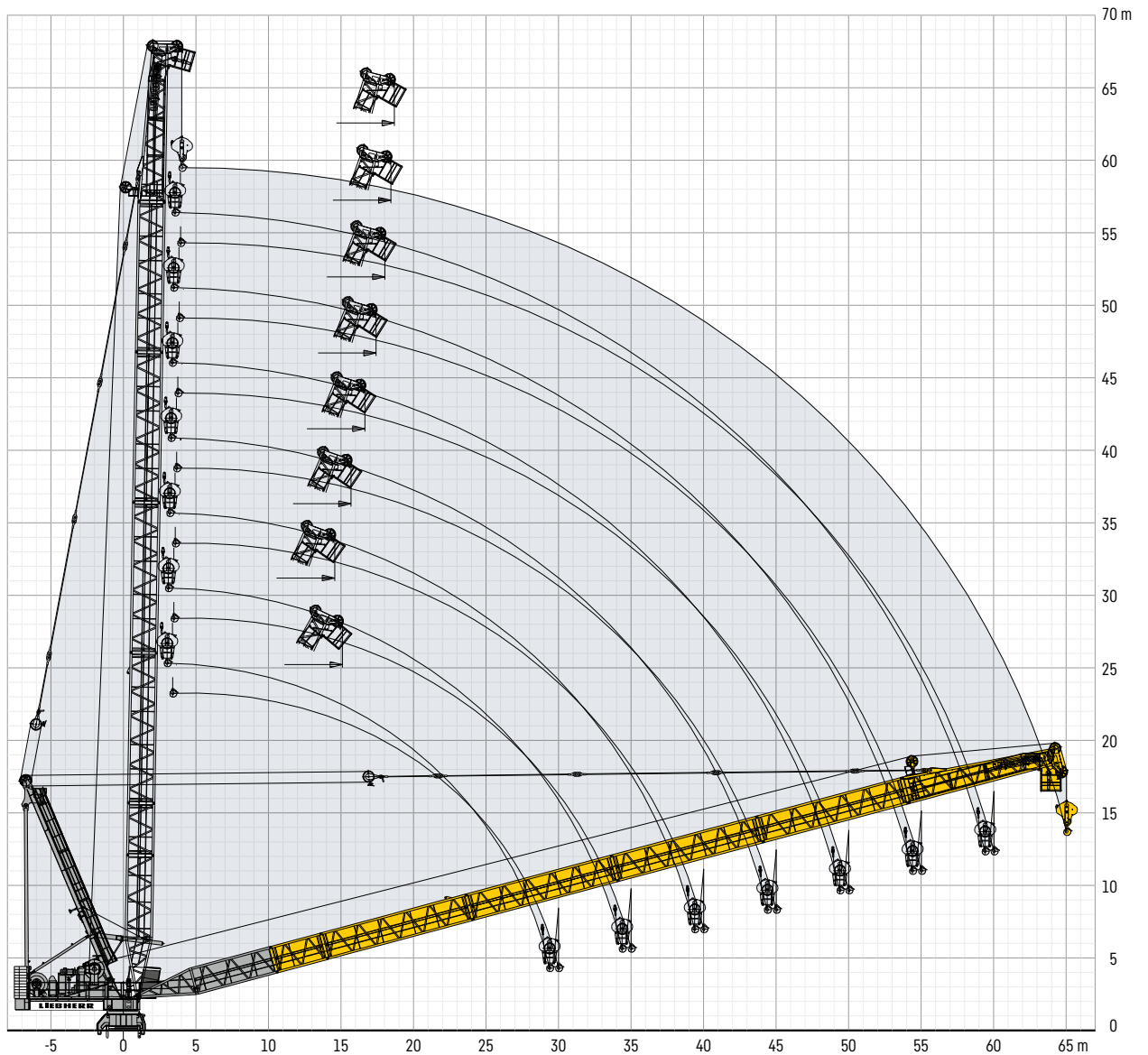

**Minimum Ausladung außer Betrieb** · Minimum radius out of operation · Portée minimum hors service · Sbraccio minimo fuori servizio · Alcance mínimo fuera de servicio · Alcance mínimo fora de operação · Минимальный вылет вне работы

**Ausleger (m)** · Jib · Flèche  
 Braccio · Pluma · Lança · Стрела

**Außerbetriebsstellung (α°)** · Out-of-operation position · Position hors service · Posizione fuori servizio  
 Posición externa de la empresa · Posição fora de operação · Положение вне работы

24 HC 630	α	↓ (m)	⊙ (m)
65	76°	18,7	-
60	75°	18,5	18,0
55	74°	18,0	17,5
50	73°	17,4	16,9
45	72°	16,7	16,2
40	71°	15,7	15,2
35	70°	14,6	14,1
30	65°	15,1	14,6

**Ausladung und Tragfähigkeit** - Radius and capacity - Portée et charge - Sbraccio e portata  
 Alcances y cargas - Alcance e capacidade de carga - Вылет и грузоподъемность

m	t	m																				
		17,5	20,0	22,5	25,0	27,5	30,0	32,5	35,0	37,5	40,0	42,5	45,0	47,5	50,0	52,5	55,0	57,5	60,0	62,5	65,0	
65,0	4,1 - 28,2	18	18,00					16,87	15,45	14,15	12,98	11,90	10,91	9,98	9,12	8,31	7,56	6,84	6,16	5,51	4,90	4,30
60,0	4,0 - 30,9	18	18,00					17,02	15,60	14,32	13,14	12,05	11,03	10,09	9,20	8,37	7,58	6,83	6,10			
	3,6 - 15,3	32	28,74	25,66	23,07	20,84	18,90	17,16	15,62	14,21	12,93	11,75	10,67	9,65	8,71	7,82	7,00	6,20	5,40	4,90		
55,0	3,9 - 33,4	18	18,00					16,99	15,53	14,18	12,94	11,78	10,71	9,69	8,73	7,80						
	3,8 - 15,5	36	32,58	29,00	25,99	23,39	21,13	19,11	17,30	15,66	14,17	12,80	11,53	10,35	9,25	8,20	7,20	6,50				
50,0	3,8 - 35,1	18	18,00					16,41	14,87	13,46	12,14	10,90	9,70									
	3,4 - 17,9	36	36,00	32,55	29,04	26,01	23,37	21,01	18,91	16,99	15,25	13,64	12,15	10,76	9,50	8,50						
45,0	3,7 - 36,5	18	18,00					17,27	15,54	13,94	12,40											
	3,3 - 20,1	36	36,00	32,09	28,57	25,49	22,75	20,30	18,06	16,03	14,14	12,40	11,10									
40,0	3,6 - 37,9	18	18,00									16,20										
	3,2 - 20,3	36	36,00	32,43	28,89	25,79	23,03	20,56	18,29	16,20	14,70											
35,0	3,5 - 35,0	18	18,00																			
	3,2 - 20,5	36	36,00	32,79	29,27	26,18	23,41	21,10														
30,0	3,5 - 30,0	18	18,00																			
	3,0 - 20,8	36	36,00	33,25	29,65	26,20																

Tragfähigkeiten gültig bis 100 m Hubhöhe. Über 100 m Hubhöhe reduziert sich die Tragfähigkeit um das zusätzliche Seilgewicht. - Lifting capacities valid up to 100 m hoisting height. Over 100 m hoisting height, the lifting capacity is reduced by the additional rope weight. - Capacités de levage valables jusqu'à 100 m de hauteur sous crochet. Au-dessus de 100 m de hauteur sous crochet, la capacité de levage est réduite du poids de câble supplémentaire. - Portate valide fino a 100 m d'altezza di sollevamento. Oltre i 100 m si riduce la portata causa il peso addizionale della fune. - Cargas válidas hasta altura de 100 m. Por encima de los 100 m se reduce la carga por el peso adicional del cable. - Cargas válidas até à altura de 100 m. Para além dos 100 m, reduz-se a carga pelo peso adicional do cabo. - Грузоподъемность действительна до 100 м высоты подъема. Свыше 100 м высоты подъема грузоподъемность сокращается на вес дополнительного каната.

**Turmhöhen** · Tower heights · Hauteur de mât · Altezze torre  
 Alturas de torre · Alturas de torre · Высота башни



<b>24 HC 630</b>							
Ausleger (m) · Jib · Flèche · Braccio · Pluma · Lança · Срепа							
	30,0	35,0 40,0	45,0 50,0 55,0	60,0 65,0	30,0	35,0 40,0 45,0 50,0 55,0	60,0 65,0
10	58,4 <sup>1)</sup>	-	-	-	-	-	-
9	52,6	52,6 <sup>1)</sup>	-	-	64,8 <sup>1)</sup>	-	-
8	46,8	46,8	46,8 <sup>1)</sup>	-	59,0	59,0 <sup>1)</sup>	-
7	41,0	41,0	41,0	41,0 <sup>1)</sup>	53,2	53,2	53,2 <sup>1)</sup>
6	35,2	35,2	35,2	35,2	47,4	47,4	47,4
5	29,4	29,4	29,4	29,4	41,6	41,6	41,6
4	23,6	23,6	23,6	23,6	35,8	35,8	35,8
3	17,8	17,8	17,8	17,8	30,0	30,0	30,0
2	12,0	12,0	12,0	12,0	24,2	24,2	24,2
1	6,2	6,2	6,2	6,2	18,4	18,4	18,4
0	0,4	0,4	0,4	0,4	12,6	12,6	12,6

m

m

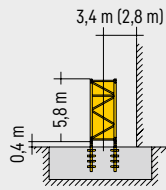

24 HC 630 FA

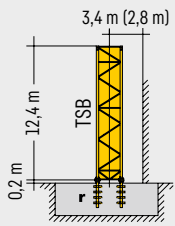

24 HC 630 FAr



# Klettern im Gebäude · Climbing in the building · Télescopage dans le bâtiment · Pure varianti di gru allungabili · Subida no edificio · Trepado dentro del edificio · Самоподъём крана в здании

**Ausladung und Turmhöhen** · Radius and tower height · Portée et hauteur de mât · Sbraccio ed altezze torri  
 Alcance y alturas de torre · Alcances e alturas da torre · Вылет и высота башни



		<b>24 HC 630</b>							
		Ausleger (m) · Jib · Flèche · Braccio · Pluma · Lança · Стрела							
n		30,0	35,0 40,0	45,0 50,0 55,0	60,0 65,0	30,0	35,0 40,0	45,0 50,0 55,0	60,0 65,0
8	h	58,4	-	-	-	58,0	-	-	-
7		52,6	52,6	-	-	52,2	52,2	-	-
6		46,8	46,8	46,8	-	46,4	46,4	46,4	-
5		41,0	41,0	41,0	41,0	40,6	40,6	40,6	40,6
4		35,2	35,2	35,2	35,2	34,8	34,8	34,8	34,8
3		29,4	29,4	29,4	29,4	29,0	29,0	29,0	29,0
2		23,6	23,6	23,6	23,6	23,2	23,2	23,2	23,2
1		17,8	17,8	17,8	17,8	17,4	17,4	17,4	17,4
0		12,0	12,0	12,0	12,0	11,6	11,6	11,6	11,6

24 HC 630 FA

<sup>1)</sup> Min. Verankerungshöhe kann bei max. Turmhöhe bzw. bei Hakenhöhe > 100 m abweichen. · Min. anchoring height may deviate at max. tower height resp. hook height > 100 m.  
 La hauteur d'ancrage min. peut différer en cas de hauteur de mât max. resp. en cas de hauteur sous crochet > 100 m. · In caso dell' altezza max torre gancio, l'altezza min. di ancoraggio può differire di > 100 m. · La altura mínima de arriostamiento puede variar con una altura máxima de torre, es decir para alturas bajo gancho > 100 m.  
 Em uma torre, com uma altura do gancho > 100 m a altura mín. do ancoramento pode variar. · Мин. высота крепления к зданию может изменяться при макс. высоте башни или при высоте крюка более 100 м.



**Antriebe** · Driving units · Mécanismes d'entraînement · Meccanismi  
Mecanismos · Mecanismos · Приводы

**3** ↑ ↓ **110 kW FU**

WIW 300 VZ 418

⊕ kVA: 221,0<sup>2)</sup>  
⊕ max. 1101 m



**4 Lagen** ↔ **stufenlos**  
Layers stepless  
Couches régl. continu  
Avvolgimenti regl. progressiva  
Camadas sin escalones  
Capas sem degraus  
Слоёв бесступенчатый

	t	m/min
1	18,00	0 ↔ 31
	8,10	0 ↔ 62
2	9,70	0 ↔ 54
	3,90	0 ↔ 107
3	5,10	0 ↔ 90
	1,25	0 ↔ 179

Geschwindigkeit · Speed · Vitesse · Velocità · Velocidad · Velocidade · Скорость

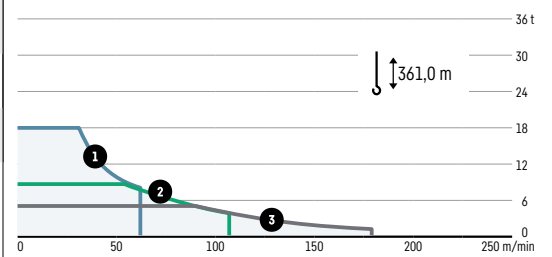

1	36,00	0 ↔ 16
	16,70	0 ↔ 31
2	20,00	0 ↔ 27
	8,70	0 ↔ 54
3	11,00	0 ↔ 45
	4,20	0 ↔ 90

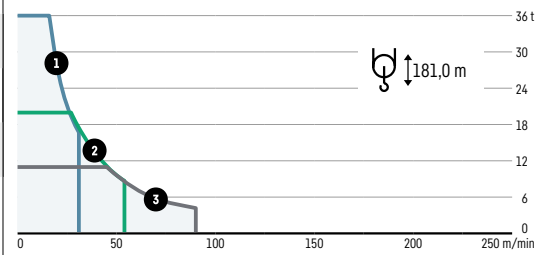

**3** ↑ ↓ **160 kW FU**

WIW 320 VZ 401

⊕ kVA: 275,0<sup>2)</sup>  
⊕ max. 1101 m



**4 Lagen** ↔ **stufenlos**  
Layers stepless  
Couches régl. continu  
Avvolgimenti regl. progressiva  
Camadas sin escalones  
Capas sem degraus  
Слоёв бесступенчатый

	t	m/min
1	18,00	0 ↔ 44
	10,50	0 ↔ 73
2	10,70	0 ↔ 72
	5,80	0 ↔ 119
3	5,30	0 ↔ 128
	2,20	0 ↔ 213

Geschwindigkeit · Speed · Vitesse · Velocità · Velocidad · Velocidade · Скорость

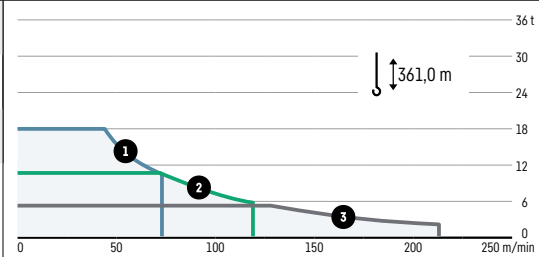

1	36,00	0 ↔ 22
	21,00	0 ↔ 37
2	22,00	0 ↔ 36
	12,00	0 ↔ 60
3	11,00	0 ↔ 64
	5,70	0 ↔ 107

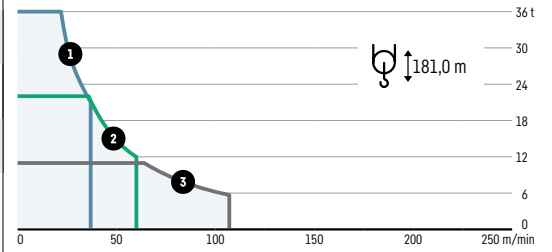

0 ↔ 0,6 U/min · sL/min · tr./min  
2 x 11 kW FU



1,8 m/min  
110 kW FU



**Unterwagen auf Anfrage** · Undercarriage on request  
Châssis sur demande · Carro su richiesta  
Carretón bajo consulta · Chassis sob consulta  
Опорная рама по запросу

<sup>2)</sup> kVA reduzierbar bei zu geringer Netz-Anschlussleistung, siehe BAL. · kVA can be reduced in case of too little power of the mains, see instruction manual.

kVA peut être réduit en cas de trop faible puissance du réseau, voir manuel d'instruction. · kVA riducibili in caso di potenza di rete ridotta (si veda manuale uso e manutenzione)  
kVA variable para potencia de red demasiado pequeña, ver Manual de instrucciones. · kVA reduzível no caso de capacidade da rede elétrica muito baixa, ver manual de instruções.  
Количество кВА может быть сокращено до минимальной общей потребляемой мощности, см. инструкцию по эксплуатации.

**Ballast** · Counterweight · Contrepoids · Zavorra · Lastre · Lastro · Балласт

**Betonballast** · Concrete ballast · Lest de beton · Zavorra in calcestruzzo · Lastre de hormigón

Lastro de betão · Бетонный балласт

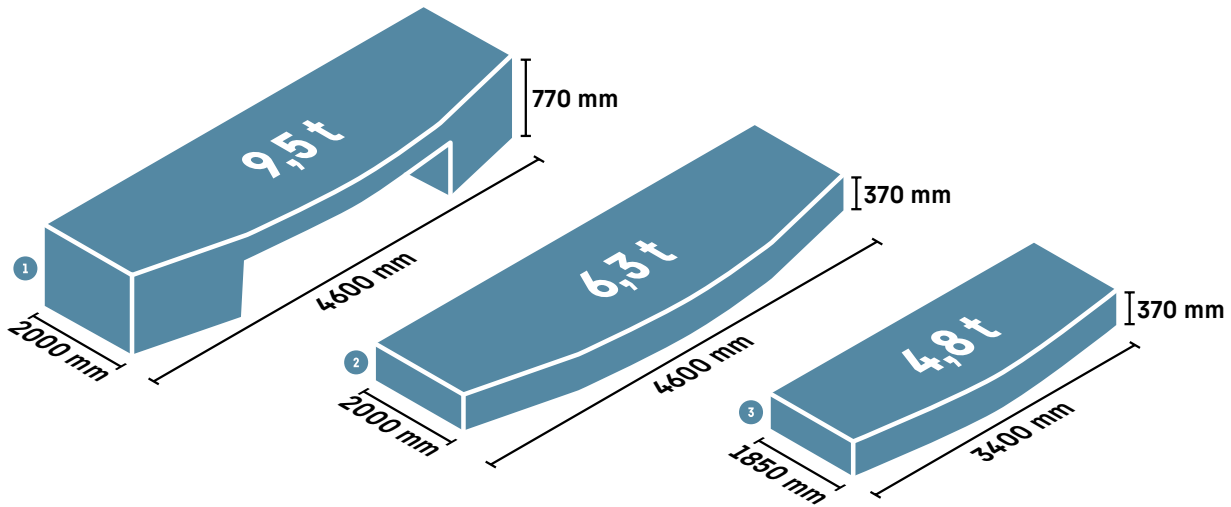

m	1 2 3			t <sup>3)</sup>	[Stacked Ballast Icon]									
	1	2	3		1	2	2	2	2	2	2	3	3	
65,0	1	5	2	50,7	1	2	2	2	2	2	3	3		
60,0	1	5	2	50,7	1	2	2	2	2	2	3	3		
55,0	1	5	2	50,7	1	2	2	2	2	2	3	3		
50,0	1	5	2	50,7	1	2	2	2	2	2	3	3		
45,0	1	5	2	50,7	1	2	2	2	2	2	3	3		
40,0	1	5	2	50,7	1	2	2	2	2	2	3	3		
35,0	1	5	2	50,7	1	2	2	2	2	2	3	3		
30,0	1	5	1	45,9	1	2	2	2	2	2	3			

**Stahlballast** · Steel ballast · Lest en acier · Contrappeso di acciaio · Lastres metálicos

Lastro metálico · Металлический балласт

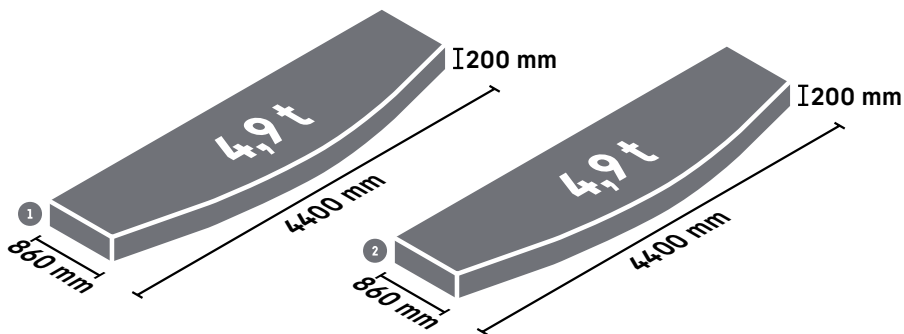

m	1 2		t <sup>3)</sup>	[Stacked Steel Ballast Icon]									
	1	2		1	1	1	1	1	2	1	1	1	1
65,0	10	1	54,0	1	1	1	1	1	2	1	1	1	1
60,0	10	1	54,0	1	1	1	1	1	2	1	1	1	1
55,0	10	1	54,0	1	1	1	1	1	2	1	1	1	1
50,0	10	1	54,0	1	1	1	1	1	2	1	1	1	1
45,0	10	1	54,0	1	1	1	1	1	2	1	1	1	1
40,0	10	1	54,0	1	1	1	1	1	2	1	1	1	1
35,0	10	1	54,0	1	1	1	1	1	2	1	1	1	1
30,0	9	1	49,0	1	1	1	1	1	2	1	1	1	

<sup>3)</sup> Gewichtsangabe inkl. Halterungen und Anbauteilen · Weight incl. mounting and add-on parts · Indication du poids, fixations et pièces à monter incl. · Le specifiche del peso includono i supporti e le parti annesse · Peso incl. soportes y piederío · Peso incluindo peças de montagem e acessórios · Данные по весу, включая элементы крепления



















 65 m

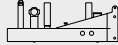

**Kolli-Liste** • Packing List • Liste de colisage • Lista dei colli • Lista de contenido  
Lista de embalagem • Упаковочный лист

**Montagegewichte: siehe Betriebsanleitung.** • Erection weights: see instruction manual. • Poids de montage: voir manuel de service. • Pesì di montaggio: vedere manuale d'uso.  
Peso para el montaje: según manual. • Pesos de montagem: veja-se as instruções p. uso. • Масса монтируемых частей: см. инструкцию по эксплуатации.

















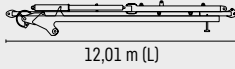

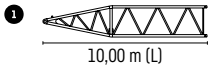







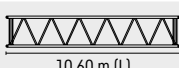



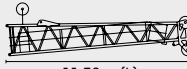

**Kranoberteil** • Upper part of crane • Partie supérieure de grue • Parte superiore della gru • Parte superior grúa  
Parte superior do guindaste • Верхняя часть крана

P <sub>1</sub>	A <sub>1</sub>	Beschreibung • Description • Description • Descrizione • Descripción • Descrição • Описание		
1a	1	<b>Drehkranz-Auflage</b> • Slewing ring support • Pivot • Ralla Corona de giro • Cremalheira • Рама поворотного круга	 2,74 m (L)  6100 kg <sup>4)</sup>	 2,27 m (H) 2,50 m (B)
1b	2	<b>Konsole</b> • Bracket • Console • Supporto Soporte • Suporte • Консоль	 1,34 m (L)  370 kg <sup>4)</sup>	10,88 m (H) 0,33 m (B)
1c	2	<b>Konsole</b> • Bracket • Console • Supporto Soporte • Suporte • Консоль	 1,33 m (L)  300 kg <sup>4)</sup>	10,64 m (H) 0,34 m (B)
2	1	<b>Drehbühne mit Rollendrehkranz</b> • Slewing platform with slewing ring Plate-forme tournante avec roulement • Piattaforma girevole con ralla Plataforma de giro con asiento de pista • Plataforma giratoria com suporte de cremalheira • Поворотная платформа с роликовым поворотным кругом	 3,00 m (L)  10800 kg <sup>4)</sup>	 2,53 m (H) 2,27 m (B)
3	1	<b>Getriebebühne mit Schaltschränken</b> • Machinery platform with switchgear cabinets • Plateforme de mecanisme avec armoires de commande • Piattaforma meccanismi con quadri elettrici • Plataforma giratoria con armarios eléctricos Plataforma de mecanismos com armários elétricos • Лебедочная платформа с распределительными электрошкафами	 6,81 m (7,80 m <sup>5)</sup> ) (L)  9750 kg <sup>4)</sup>	 2,56 m (H) 2,23 m (B)
4	1	<b>Hubwerk 160 kW mit Sekundärbremse (ohne Hubseil)</b> • Hoist gear with sec- ondary brake (without hoist rope) • Mécanisme de levage avec frein secondaire (sans câble de levage) • Argano di sollevamento con freno ausiliario (senza fune di sollevamento) • Mecanismo de elevación con freno secundario (sin cable de elevación) • Mecanismo de elevação com freio auxiliar (sem cabo de elevação) Механизм подъема с вторичным тормозом (без грузового каната)	 3,90 m (L)  6500 kg <sup>4)</sup>	 2,00 m (H) 2,45 m (B)
5	1	<b>Einziehwerk 110 kW mit Sekundärbremse (ohne Einziehseil)</b> • Luffing gear with secondary brake (without luffing rope) • Mécanisme de relevage avec frein secondaire (sans cable de relevage) • Argano di sollevamento braccio con freno ausiliario (senza fune di ritrazione) • Mecanismo de pluma batiente con freno secundario (sin cable retractil) • Mecanismo de Lanea batente con freio auxiliar (sem cabo de basculamento) • Стрелоподъемный механизм с вторичным тормозом (без стрелового каната)	 3,10 m (L)  4900 kg <sup>4)</sup>	 1,60 m (H) 2,32 m (B)

P<sub>1</sub> = Position • Item • Position • Posizione • Posición • Posição • Положение A<sub>1</sub> = Anzahl • Quantity • Nombre • Numero • Cantidad • Número • Количество

<sup>4)</sup> Einzelgewichte • Single weights • Poids individuels • Singoli pesi • Tramo punta de pluma • Pesos de peças componentes • Индивидуальный вес

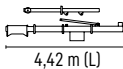



<sup>5)</sup> Mit Verlängerung • With extension • Avec extension • Con estensione • Con extensión • Com extensão • С удлинением контрстрелы

P <sub>1</sub>	A <sub>1</sub>	Beschreibung · Description · Description · Descrizione · Descripción · Descrição · Описание		
6	1	<b>Kabine mit Podest</b> · Cabin with platform · Cabine avec plate-forme Cabina con pedana · Cabina con plataforma · Cabina com plataforma Кабина с площадкой	 6,00 m (L)  2500 kg <sup>4)</sup>	 2,20 m (B) 2,57 m (H)
7	3	<b>Seitenpodest</b> · Side platform · Plate-forme latérale · Pedana laterale Plataforma lateral · Plataforma lateral · Боковая площадка	 6,50 m (L)  400 kg <sup>4)</sup>	 1,20 m (B) 1,00 m (H)
8	1	<b>Auslegerhaltebock, geteilt</b> · Jib retaining frame, split · Chevalet de retenue de flèche, en éléments · Cavalletto tirante braccio, diviso · Caballete de soporte de pluma, dividido · Cavalete de suporte da lança, dividido · Кронштейн стрелы, составной	 12,01 m (L)  10500 kg <sup>4)</sup>	 2,28 m (B) 2,56 m (H)
9	1	<b>Ausleger-Anlenkstück</b> · Jib heel section · Pied de flèche Sezione articolata braccio · Pluma tramo primero Base articulada de lança · Корневая секция стрелы	 10,00 m (L)  3200 kg <sup>4)</sup>	 1,90 m (H) 1,96 m (B)
10	1	<b>Ausleger-Zwischenstück 3,6 m</b> · Intermediate jib section Élément intermédiaire de flèche · Sezione intermedia braccio Tramo intermedio pluma · Peça suplementar da lança Промежуточная секция стрелы	 3,85 m (L)  1250 kg <sup>4)</sup>	 1,90 m (H) 1,91 m (B)
11	1	<b>Ausleger-Zwischenstück 10,36 m (Festpunkt)</b> · Intermediate jib section (fixed point) · Élément intermédiaire de flèche (point fixe) · Sezione intermedia braccio (punto fisso) · Tramo intermedio pluma (punto fijo) · Tramo intermédio da lança (ponto fixo) · Промежуточная секция стрелы (Фиксированная точка)	 10,60 m (L)  2800 kg <sup>4)</sup>	 2,10 m (H) 1,93 m (B)
12	3	<b>Ausleger-Zwischenstück 10,36 m</b> · Intermediate jib section Élément intermédiaire de flèche · Sezione intermedia braccio Tramo intermedio pluma · Peça suplementar da lança Промежуточная секция стрелы	 10,60 m (L)  2400 kg <sup>4)</sup>	 1,90 m (H) 1,92 m (B)
13	1	<b>Ausleger-Zwischenstück 5,18 m (Festpunkt)</b> · Intermediate jib section (fixed point) · Élément intermédiaire de flèche (point fixe) · Sezione intermedia braccio (punto fisso) · Tramo intermedio pluma (punto fijo) · Tramo intermédio da lança (ponto fixo) · Промежуточная секция стрелы (Фиксированная точка)	 5,50 m (L)  1350 kg <sup>4)</sup>	 2,10 m (H) 1,91 m (B)
14	1	<b>Ausleger-Kopfstück</b> · Jib head section · Pointe de flèche Punta braccio · Tramo punta de pluma · Cabeça de lança Концевая секция стрелы	 11,50 m (L)  4000 kg <sup>4)</sup>	 2,00 m (B) 2,55 m (H)
15	1	<b>Unterflasche</b> · Bottom hook block · Moufle inférieure Bozzello inferiore · Polipasto inferior · Gincho inferior Крюковая обойма	 2,45 m (L)  2000 kg <sup>4)</sup>	 1,45 m (B) 0,80 m (H)
16	1	<b>Einziehseilflasche</b> · Luffing rope pulley block · Tambour de relevage Bozzello di sollevamento braccio · Polipasto cable de retracción Gincho de cabo de retração · Замок стрелового каната	 1,50 m (L)  600 kg <sup>4)</sup>	 1,20 m (B) 1,20 m (H)
17	1	<b>Hilfskran mit Lagerungen</b> · Auxiliary crane with supports Grue auxiliaire avec logements · Gru auxiliaria con supporti Grúa auxiliar con apoyos · Grua auxiliar com apoios Вспомогательный кран	 4,42 m (L)  800 kg <sup>4)</sup>	 0,60 m (B) 0,90 m (H)



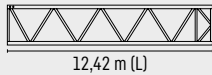

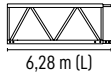

P<sub>1</sub> = Position · Item · Position · Posizione · Posición · Posição · Положение    A<sub>1</sub> = Anzahl · Quantity · Nombre · Numero · Cantidad · Número · Количество

<sup>4)</sup> Einzelgewichte · Single weights · Poids individuels · Singoli pesi · Tramo punta de pluma · Pesos de peças componentes · Индивидуальный вес

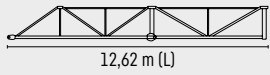







## Turm · Tower · Mât · Torre · Torre · Torre · Башня

P <sub>1</sub>	A <sub>1</sub>	Beschreibung · Description · Description · Descrizione · Descripción · Descrição · Описание			
18	1	<b>Grundturmstück</b> · Base tower section · Mât de base · Elemento di torre base Tramo base · Peça de base de torre · Секция основания	24 HC 630 TSB-1242c		
				12,42 m (L)	2,68 m (H) 2,68 m (B)
				14500 kg <sup>(4)</sup>	
19	1	<b>Turmstück</b> · Tower section · Élément de mât · Elemento di torre Tramo torre · Torre · Башенная секция	24 HC 630 TS-0580c		
				6,28 m (L)	2,45 m (H) 2,45 m (B)
				6450 kg <sup>(4)</sup>	

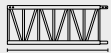



## Klettern am Gebäude · Climbing on the building · Télésopage à l'extérieur du bâtiment · Telescopaggio esterno all'edificio Trepado exterior a edificio · Telescopagem exterior ao edifício · Нарращивание высоты крана, пристыгнутого к зданию

P <sub>1</sub>	A <sub>1</sub>	Beschreibung · Description · Description · Descrizione · Descripción · Descrição · Описание			
20	2	<b>Führungsstück-Hälfte mit Podesten</b> · Guide section with platforma Cage télescopique avec plate-formes · Sezione guida con pedane Tramo guía con plataforma · Tramo guía com plataforma Половина направляющей секции с площадками			
				12,62 m (L)	1,75 m (H) 2,95 m (B)
				5000 kg <sup>(4)</sup>	
21	1	<b>Hydraulikanlage und Klettereinrichtung</b> · Hydraulic unit and climbing equipment · Système hydraulique et équipement de télésopage Impianto idraulico e dispositivo di telescopaggio · Sistema hidráulico y equipo de trepado · Sistema hidráulico e telescopagem · Гидроагрегат и обойма наращивания			
				3100 kg <sup>(4)</sup>	

## Klettern im Gebäude · Climbing in the building · Télésopage dans le bâtiment · Pure varianti di gru allungabili Subida no edificio · Trepado dentro del edificio · Самоподъем крана в здании

P <sub>1</sub>	A <sub>1</sub>	Beschreibung · Description · Description · Descrizione · Descripción · Descrição · Описание					
22		<b>Kletterturmstück (D-St.)</b> · Climbing tower section Elément de hissage de mât · Elemento torre di telescopaggio Tramo de trepado · Tramo de telescopagem · Секция самоподъема					
	1			L (m)	B (m)	H (m)	kg <sup>(4)</sup>
		380 IC		6,28	1,90	2,81	9300
		24 HC 630 - D1		6,30	2,45	2,45	9600
	1	24 HC 630 - D2		6,30	2,45	2,45	9400
23	1	<b>Hydraulikanlage und Klettertraverse</b> · Hydraulic unit and climbing cross members · Système hydraulique avec traverses de télésopage Impianto idraulico e traverse di allungamento · Equipo hidráulico y traviesa de trepado · Equipamento hidráulico e travessa de telescopagem Гидроагрегат и траверса наращивания		L (m)	B (m)	H (m)	kg <sup>(4)</sup>
		355/380 IC		2,50	0,80	0,60	1500
		24 HC 630		-	-	-	3150
24	1	<b>Einspannturmstück (B-St.)</b> · Anchoring tower section Elément de mât d'encastrement · Elemento torre d'ancoraggio Tramo de torre inferior de trepado · Tramo de telescopagem inferior Упорная секция					
				L (m)	B (m)	H (m)	kg <sup>(4)</sup>
		355 IC		6,28	1,90	1,90	6600
		24 HC 630		6,30	2,45	2,45	9300
25	6	<b>Führungsrahmen (Hälfte)</b> · Guide frame (half) Cadre de hissage (moitié) · Telaio guida (metà) Bastidor guía (mitad) · Bastidor de guía (metade) Направляющая рама (половина)					
				L (m)	B (m)	H (m)	kg <sup>(4)</sup>
		355/380 IC		3,55	0,78	0,48	2500
		24 HC 630		3,05	0,95	0,65	1700
26	1	<b>Kletterleiter</b> · Climbing ladder · Echelle de télésopage Scala di telescopaggio · Escalera de trepar Régua para telescopagem · Лестница самоподъема					
				L (m)	B (m)	H (m)	kg <sup>(4)</sup>
		355/380 IC		5,10	0,40	0,10	490
		24 HC 630		5,70	0,45	0,15	530

## Ballast · Ballast · Lest · Zavorra · Lastre · Lastro · Балласт

P <sub>1</sub>	A <sub>1</sub>	Beschreibung · Description · Description · Descrizione · Descripción · Descrição · Описание					
27	10 1	<b>Stahlballast</b> · Steel ballast · Lest en acier · Contrappeso di acciaio Lastres metálicos · Lastro metálico · Металлический балласт					
			L (m)	B (m)	H (m)	kg <sup>4)</sup>	
			4,40	0,20	0,86	4900	
			4,40	0,20	0,86	4900	
28	1 5 2	<b>Betonballast</b> · Concrete ballast · Lest de beton · Zavorra in calcestruzzo Lastre de hormigón · Lastro de betão · Бетонный балласт					
			L (m)	B (m)	H (m)	kg <sup>4)</sup>	
			4,60	0,77	2,00	9500	
			4,60	0,37	2,00	6300	
			3,40	0,37	1,85	4800	

## Kleinteile · Small parts · Accessoires · Accessori · Accesorios · Acessórios · Мелкие детали

P <sub>1</sub>	A <sub>1</sub>	Beschreibung · Description · Description · Descrizione · Descripción · Descrição · Описание	
29	1	<b>Kleinteile, Podeste, Seile und Abspannungen</b> · Small parts, platforms, ropes and holding bars Accessoires, plates-formes, câbles et tirants · Accessori, pedana, funi e attrezzi di ancoraggio Despieces, plataformas, cables y tirantes · Acessórios, plataformas, cabos e peças de ancoragem Мелкие детали, Площадки, Канаты и Пристежки	 4500 kg <sup>4)</sup>

P<sub>1</sub> = Position · Item · Position · Posizione · Posición · Posição · Положение    A<sub>1</sub> = Anzahl · Quantity · Nombre · Numero · Cantidad · Número · Количество

<sup>4)</sup> Einzelgewichte · Single weights · Poids individuels · Singoli pesi · Tramo punta de pluma · Pesos de peças componentes · Индивидуальный вес



**Sämtliche Angaben erfolgen ohne Gewähr.**

This information is supplied without liability.

Ces renseignements sont sans garantie.

Tutte le indicazioni fornite senza garanzia.

Declinamos toda responsabilidad derivada de la información proporcionada.

Declinamos qualquer responsabilidade quanto à informação fornecida.

Все данные указаны без обязательств.

**Änderungen vorbehalten!**

Subject to technical modifications!

Sous réserves de modifications !

Con riserva di modifiche!

¡Sujeto a modificaciones sin previo aviso!

Sujeto a modificações!

С правом внесения изменений!