

Turmdrehkran

Tower Crane / Grue à tour / Gru a torre / Grúa torre
Guindaste de torre / Башенный поворотный кран

200 EC-H 12 FR.tronic®

200 EC-H 10 FR.tronic®

200 EC-H 10 Litronic®

▶ 200 EC-H 12 FR.tronic®

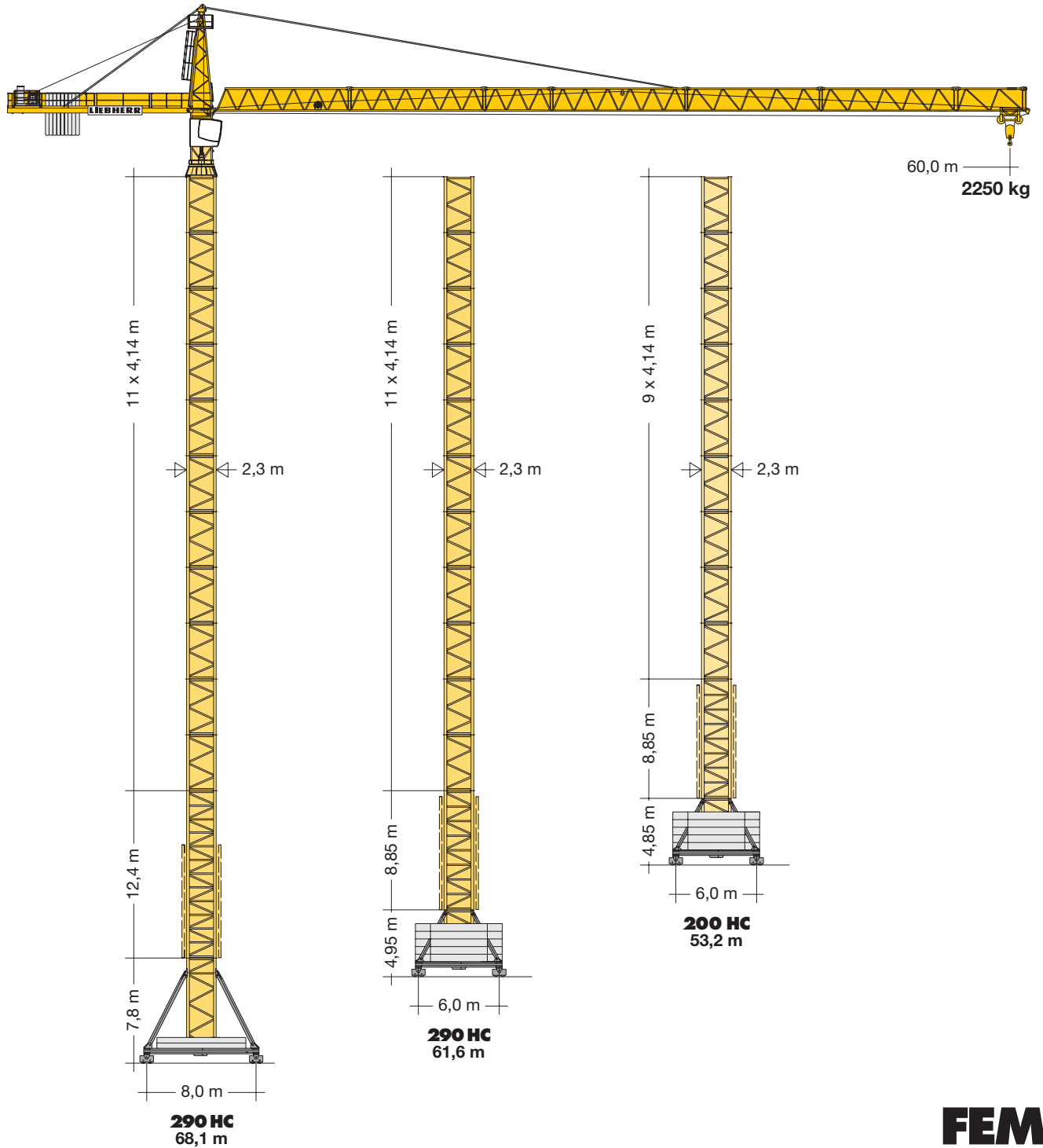

LIEBHERR

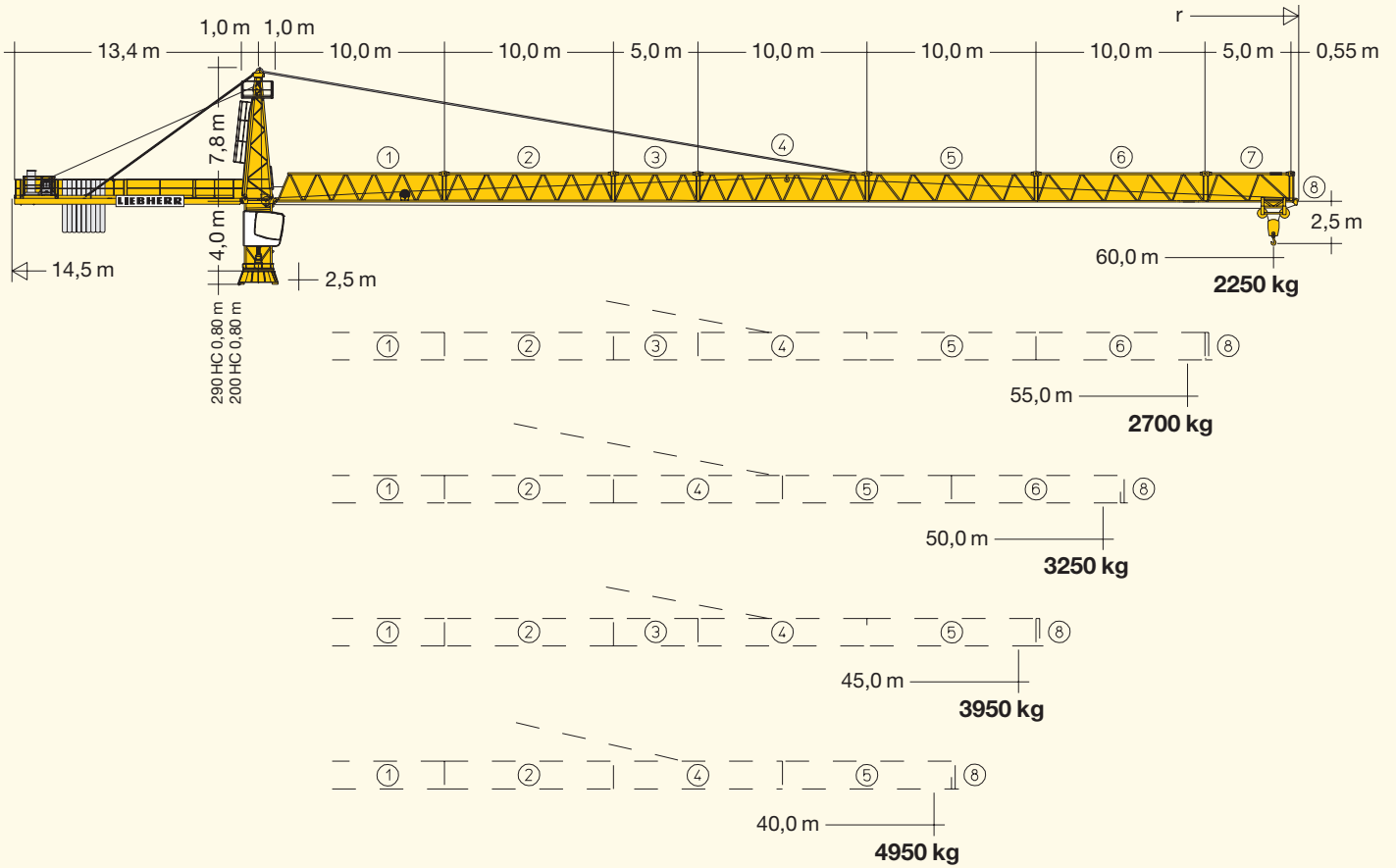

Hubhöhe

Hoisting height / Hauteur sous crochet / Altezza di sollevamento
 Altura bajo gancho / Altura de montagem / Высота подъема

	200 HC			290 HC						
12	-	-	-	-	64,6*	-	-	-	-	-
11	-	-	-	56,9*	60,5*	-	-	-	-	-
10	52,8*	-	-	52,8	56,3	61,6*	65,2*	-	-	68,1*
9	48,6*	53,2*	50,0*	48,6	52,2	57,5	61,1*	54,1*	57,7*	63,9
8	44,5	49,0	45,9	44,5	48,0	53,3	56,9	50,0	53,6	59,8
7	40,3	44,9	41,7	40,3	43,9	49,2	52,8	45,9	49,4	55,6
6	36,2	40,7	37,6	36,2	39,8	45,0	48,7	41,7	45,3	51,5
5	32,1	36,6	33,4	32,1	35,6	40,9	44,5	37,6	41,2	47,4
4	27,9	32,5	29,3	27,9	31,5	36,8	40,4	33,4	37,0	43,2
3	23,8	28,3	25,2	23,8	27,3	32,6	36,2	29,3	32,9	39,1
2	19,6	24,2	21,0	19,6	23,2	28,5	32,1	25,2	28,7	34,9
1	15,5	20,0	16,9	15,3	19,1	24,3	28,0	21,0	24,6	30,8
0	11,4	15,9	12,7	11,4	14,9	20,2	23,8	16,9	20,5	26,7
	m			m	a) b)	a) b)	a) b)	a) b)		

* Weitere Hubhöhen, Auslegerlängen sowie Klettern im Gebäude auf Anfrage. / Further hoist heights and jib lengths as well as climbing inside the building on request. / Autres hauteurs sous crochet et longueurs de flèche ainsi que hissage dans le bâtiment sur demande. / Ulteriori altezze gancho, lunghezze braccio così come telescopaggio all'interno dell'edificio: su richiesta. / Para alturas bajo gancho superiores, otros alcances y trepado en el interior del edificio, consultar. / Outras alturas de elevação, comprimentos de lança e subida no edifício: sob consulta. / Другие высоты подъема, длины стрелы и самоподъем в здании – по запросу.

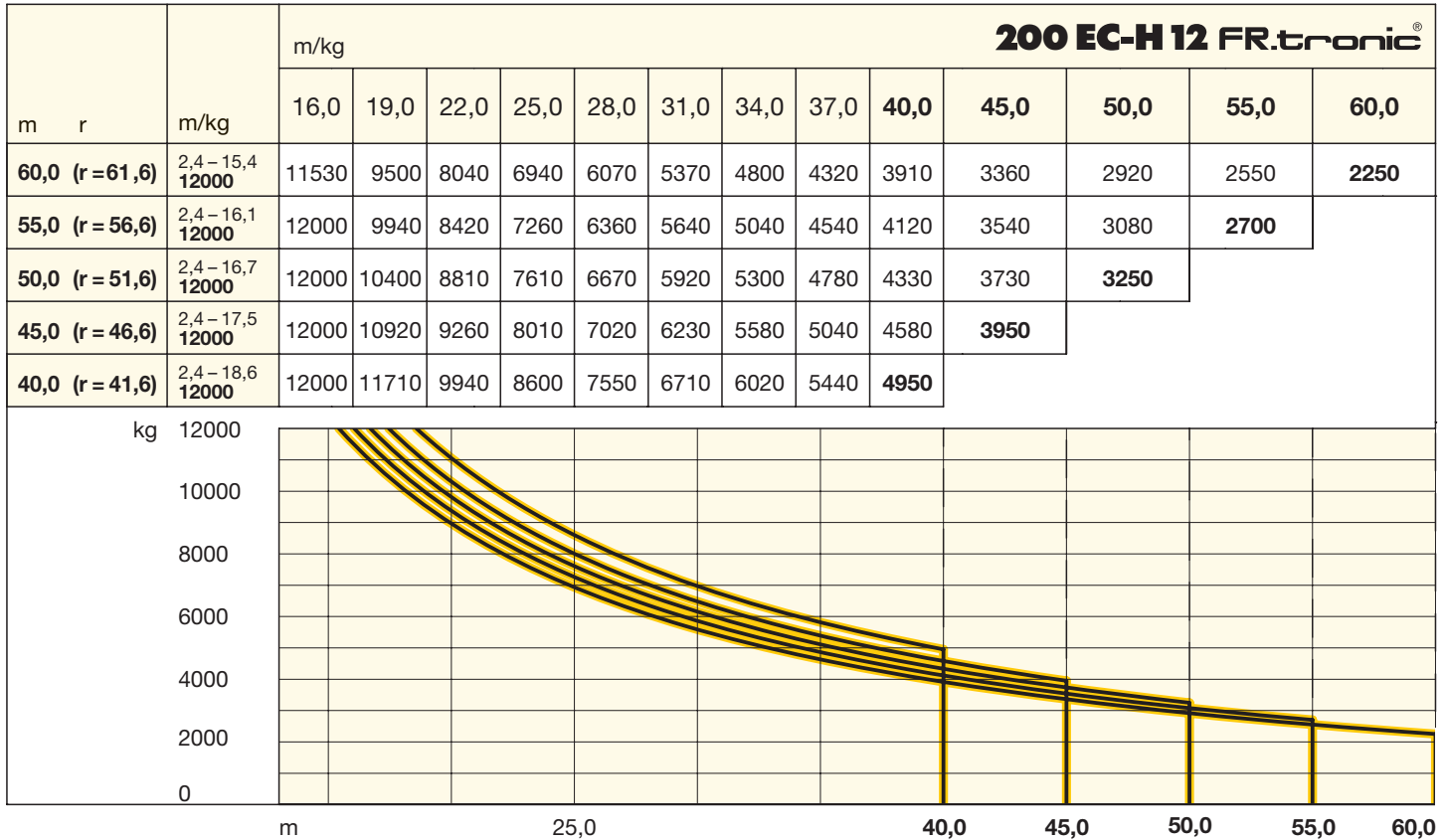

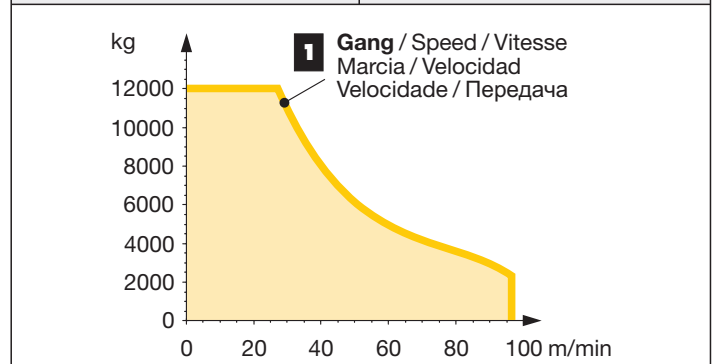
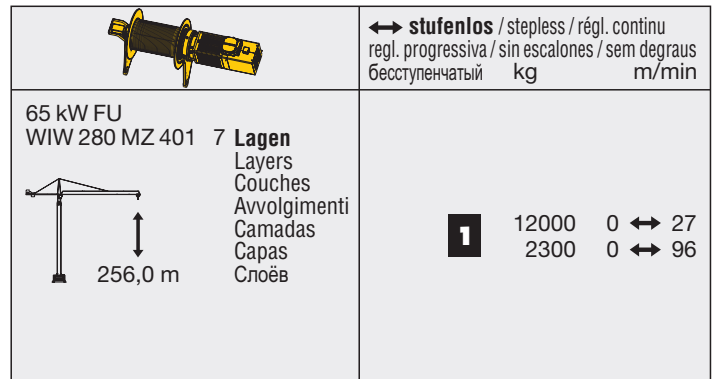
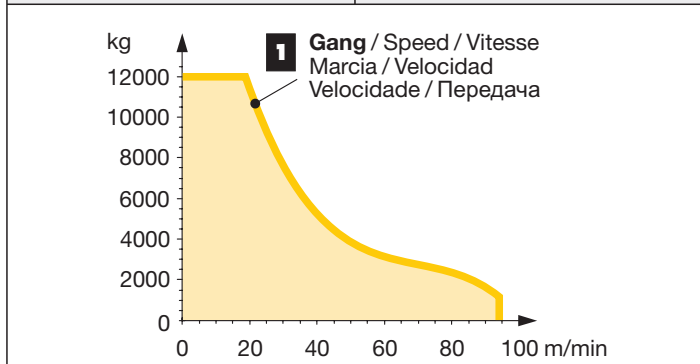
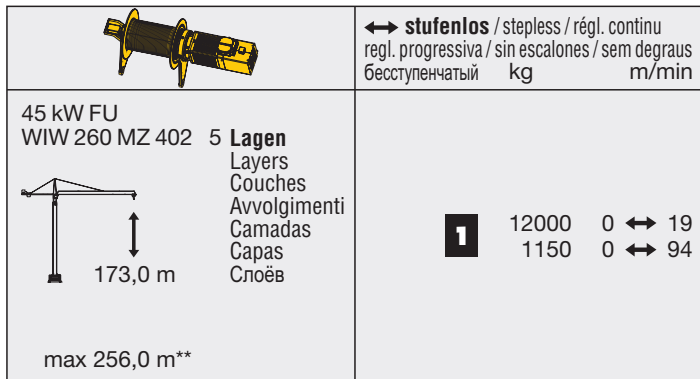

Antriebe FR.tronic®

Driving units / Mécanismes d'entraînement
Meccanismi / Mecanismos / Mecanismos / Приводы



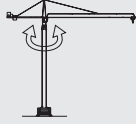
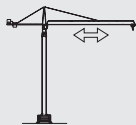



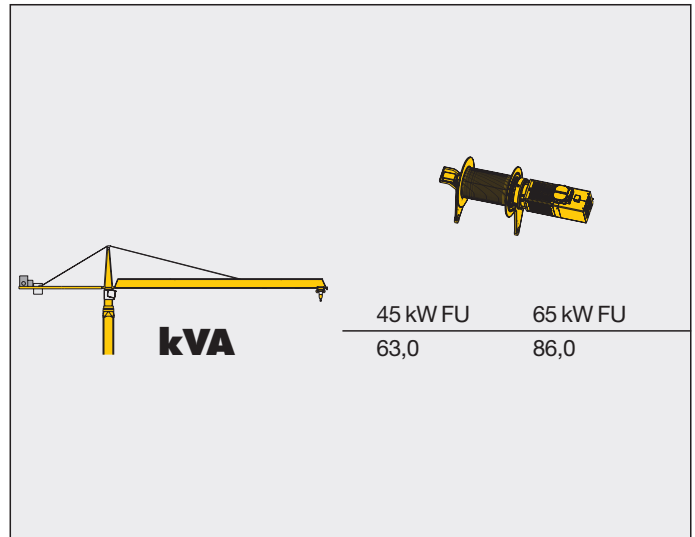





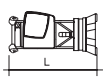

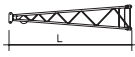







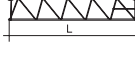



** Weitere Hublastdaten: siehe Betriebsanleitung. / Further hoist load data: see instruction manual. / Autres données de la charge de levage: voir manuel d'instruction. / Altri dati sui carichi sollevati: consultare il manuale d'istruzione. / Alturas bajo granchos superiores según manual. / Outras tabelas de carga: consultar manual de instruções. / Другие данные по весу поднимаемых грузов: см. инструкцию по эксплуатации.

	0 ↔ 0,8 U/min sl./min tr./min	2 x 7,5 kW FU
	0 ↔ 110,0 m/min	7,5 kW FU
	25,0 m/min	2 x 5,5 kW (200 HC) 2 x 7,5 kW (290 HC)

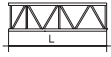

Kolli-Liste Packing List / Liste de colisage / Lista dei colli
Lista de contenido / Lista de embalagem / Упаковочный лист







Montagegewichte: siehe Betriebsanleitung. / Erection weights: see instruction manual. / Poids de montage: voir manuel de service. / Pesì di montaggio: vedere manuale d'uso. / Peso para el montaje: según manual. / Pesos de montagem: vejã-se as instruções p. uso. / Масса монтируемых частей: см. инструкцию по эксплуатации.

Kranoberteil		Upper part of crane / Partie supérieure de grue / Parte superiore della gru Parte superior grúa / Parte superior do guindaste / Верхняя часть крана	L (m)	B (m)	H (m)	kg*		
Pos. Item	Anz. Qty.	Drehbühne kpl. / Slewing platform cpl. Ensemble mât cabine cpl. / Piattaforma girevole compl. / Conjunto plataforma de giro Plataforma giratória compl. / Поворотная платформа в сб.			200 HC 5,40 290 HC 5,40	2,80 2,80	2,64 2,64	8400 8400
2	1	Turmspitze / Tower head section / Porte-flèche Testa porta-braccio / Cabeza de torre / Cabeça de apoio de lança / Оголовок башни			7,90	1,48	1,91	1900
3	1	Gegenausleger / Counter-jib / Contre-flèche Controfreccia / Contrapluma / Contra-lança Консоль противовеса			13,50	2,30	0,61	3500
4	1	Hubwerkseinheit / Hoist gear unit / Treuil de levage Gruppo meccanismo sollevamento / Mecanismo de elevación / Grupo de mecanismo elevatório / Блок грузовой лебедки			45 kW 2,20	2,39	1,74	3300
5	1	Ausleger-Anlenkstück / Jib heel section / Pied de flèche Sezione articolata braccio / Pluma tramo primero / Base articulada de lança / Корневая секция стрелы			10,29	1,71	1,98	① 2390
6	4	Ausleger-Zwischenstück / Intermediate jib section Élément intermédiaire de flèche / Sezione intermedia braccio / Tramo intermedio pluma / Peça suplementar da lança / Промежуточная секция стрелы			10,30	1,50	1,90	② 1570 ④ 1400 ⑤ 1100 ⑥ 710
7	2	Ausleger-Zwischenstück / Intermediate jib section Élément intermédiaire de flèche / Sezione intermedia braccio / Tramo intermedio pluma / Peça suplementar da lança / Промежуточная секция стрелы			5,30	1,50	1,90	③ 710 ⑦ 350
8	1	Ausleger-Kopfstück / Jib head section / Pointe de flèche Punta braccio / Tramo punta de pluma Cabeça de lança / Концевая секция стрелы			0,72	1,66	2,03	⑧ 240
9	1	Laufkatze und Lasthaken / Trolley and hook Chariot de distribution et crochet / Carrello con gancio / Carrito y gancho / Carro de ponte e gancho / Грузовая тележка и грузовой крюк			1,87	1,69	1,57	1050
Turm		Tower / Mât / Torre Torre / Torre / Башня						
10	8-9 9-10 10-12	Turmstück / Tower section Élément de mât / Elemento di torre Tramo torre / Torre / Башенная секция			200 HC 4,14 290 HC 4,14	2,30 2,30	2,30 2,30	2240 2300
11	1	Turmstück lang / Long tower section / Élément de mât long Elemento di torre, lungo / Tramo de torre largo Peça de torre, comprida / Башенная секция, длинная			200 HC 12,42 290 HC 12,42	2,30 2,30	2,30 2,30	5460 5770
12	1	Grundturmstück / Base tower section / Mât de base Elemento di torre base Tramo base Peça de base de torre / Секция основания			200 HC 8,85 290 HC 8,85 (12,42)	2,30 2,30 (2,30)	2,30 2,30 (2,30)	4280 4830 (7940)

Pos. Anz.
Item Qty.
Rep. Qte.
Voce Qta.
Pos. Cant.
Ref. Cant.
Поз. Кол-во

L (m) B (m) H (m) kg*

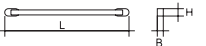
Klettereinrichtung Climbing equipment / Equipement de télescopage / Attrezzatura per allungamento della gru Equipo de trepado / Acesoários p. subida no edifício / Обойма наращивания

13	1	Führungsstück kpl. / Guide section cpl. / Cage télescopique cpl. / Gabbia de sopraelevazione compl. Torre de montaje completa / Peça de guia compl. Направляющая секция в сб.		200 HC 290 HC	8,39 8,39	2,68 2,68	2,58 (3,04) 2,58 (3,04)	5210 5210	
14	1	Hydraulikanlage, Stütz- und Klettertraverse / Hydraulic unit, supporting and climbing cross members / Système hydraulique avec traverses d'appui et de télescopage / Sistema hidráulico, travesa de appoggio e allugamento gru Sistema hidráulico con travesa de apoyo y trepado / Instalação hidráulica, tavassa de apoio e subida / Гидроагрегат, стойка-упор и траверса обоймы наращивания		200 HC 290 HC	2,30 2,30	1,25 1,25	1,00 1,00	1150 1300	
Unterwagen Undercarriage / Châssis / Carro									
Carro con mástil / Carro de guindaste / Опорная рама									
15	2	Fahrschemel mit Antrieb / Rail bogie with drive Bogie moteur / Telaio con gruppo propulsore Caja rodillo motriz / Quadro sem grupo de propulsão Подрамник с приводом		200 HC 290 HC	1,46 1,63 (1,46)	0,84 0,92 (0,84)	0,87 0,95 (0,87)	920 1690 (920)	
16	2	Fahrschemel ohne Antrieb / Rail bogie without drive Bogie fou / Telaio senza gruppo propulsore / Caja rodillo conducido / Quadro com grupo de propulsão Подрамник без привода		200 HC 290 HC	1,15 1,37 (1,15)	0,60 0,62 (0,60)	0,87 0,95 (0,87)	880 1340 (880)	
17	1	Tragholm lang / Long support arm / Longeron long Longherone lungo / Brazo soporte largo / Travessa comprida / Несущая балка, длинная		200 HC 290 HC	9,10 9,10 (11,95)	0,82 0,80 (0,82)	0,74 0,80 (0,80)	1350 1650 (2200)	
18	2	Tragholm kurz / Short support arm / Longeron court Longherone corto / Brazo soporte corto / Travessa curta / Несущая балка, короткая		200 HC 290 HC	4,41 4,45 (5,58)	0,62 0,77 (0,65)	0,71 0,77 (0,77)	615 850 (1035)	
19	2 + 2	Randträger / Border support / Traverse Supporti base / Traviesa / Apoio de bordo Стяжная балка		200 HC 290 HC	5,48 – 5,46 5,46 – 5,40 (7,52 – 7,46)	0,11 – 0,17 0,11 – 0,18 (0,10 – 0,17)	0,16 – 0,38 0,16 – 0,38 (0,10 – 0,38)	60 – 230 95 – 270 (183 – 460)	
20	4	Stützholm / Support strut / Hauban de châssis Correnti di appoggio / Tirante vertical / Travessa de apoio / Опорный подкос		200 HC 290 HC	4,23 4,14 (6,55)	0,17 0,18 (0,22)	0,25 0,25 (0,25)	275 330 (600)	
21	1	Unterwagen-Turmstück / Undercarriage tower section / Mât de châssis / Elemento di torre del carro Tramo de carro / Peça de torre do chassis Опорная башенная секция		200 HC 290 HC	3,73 3,73 (6,70)	2,52 2,62 (2,53)	2,52 2,62 (2,53)	2050 3000 (4200)	
22	1	Kleinteile, Seile und Abspannungen / Small parts, ropes and holding bars Acessorios, câbles et tirants / Accessori, funi e attrezzi di ancoraggio Despieces, cables y tirantes / Acesoários, cabos e peças de ancoragem Мелкие детали, Канаты и Пристежки		200 HC 290 HC	9,00	1,60	1,00	4000	

() **Angaben in Klammern gelten für 8 m-Unterwagen.** / The data in brackets are valid for an undercarriage of 8 m. / Les données techniques indiquées entre parenthèses sont valables pour un châssis de 8 m. / Caratteristiche in (...) valgono per carro di 8 m. / Los datos entre paréntesis son válidos para carro de 8 m. Características em (...) válidas pelo chassis de 8 m. / Данные в скобках относятся к 8-метровой опорной раме

* **Einzelgewichte.** / Single weights. / Poids individuels. / Singoli pesi. / Pesos unitarios. / Pesos de peças componentes. / Индивидуальный вес.

Konstruktionsänderungen vorbehalten! / Subject to alterations! / Sous réserves de modifications! / Riservato il diritto di modifiche strutturali! / ¡Sujeto a modificaciones! / Salvo modificação da construação! / Права на внесение конструкторских изменений сохраняются!

Sämtliche Angaben erfolgen ohne Gewähr. / This information is supplied without liability. / Ces renseignements sont sans garantie. / Tutte le indicazioni fornite senza garanzia. / Declinamos toda responsabilidad derivada de la información proporcionada. / Declinamos qualquer responsabilidade quanto à informação fornecida. / Все данные указаны без обязательств.

121 P – 2865 FEM (Section 1) Krangruppe A3 • 04.10 / 7

Printed in Germany.